

Product Manual

1110 - Touch Sensor

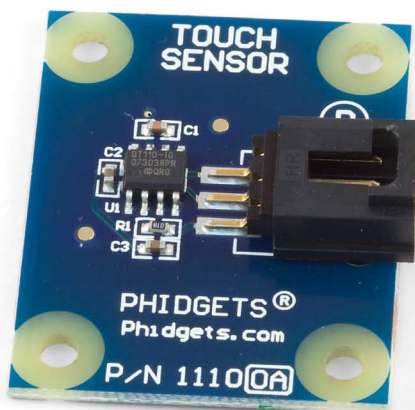

Phidgets 1110 - Product Manual

For Board Revision 0

© Phidgets Inc. 2009

Contents

4 Product Features

- 4 Connections
- 4 Type of Measurement

5 Getting Started

- 5 Checking the Contents
- 5 Connecting all the pieces
- 5 Testing Using Windows 2000/XP/Vista
- 7 Testing Using Mac OS X

7 Programming a Phidget

- 7 Code Samples
- 7 Coding for your Sensor

8 Technical Information

- 8 Other Interfacing Alternatives
- 8 Analog Input Cable Connectors
- 9 Mechanical Drawing
- 9 Device Specifications

9 Product History

9 Support

Product Features

- The Touch Sensor is a capacitive touch sensor and can detect a touch through plastic, glass, or paper.
- We recommend a material thickness of 1/8”.

Connections

Designed to connect to a:

- 1018 - PhidgetInterfaceKit 8/8/8
- 1019 - PhidgetInterfaceKit 8/8/8 w/6 Port Hub
- 1070 - PhidgetSBC
- 1202 or 1203 - PhidgetTextLCD

Type of Measurement

The sensor uses ratiometric measurement.

Getting Started

Checking the Contents

You should have received:

- A Touch Sensor
- A Sensor Cable

In order to test your new Phidget you will also need:

- A PhidgetInterfaceKit 8/8/8 or a PhidgetTextLCD
- A USB Cable

Connecting all the pieces

1. Connect the Touch Sensor to the Analog Input 6 on the PhidgetInterfaceKit 8/8/8 using the sensor cable.
2. Connect the PhidgetInterfaceKit to your PC using the USB cable.

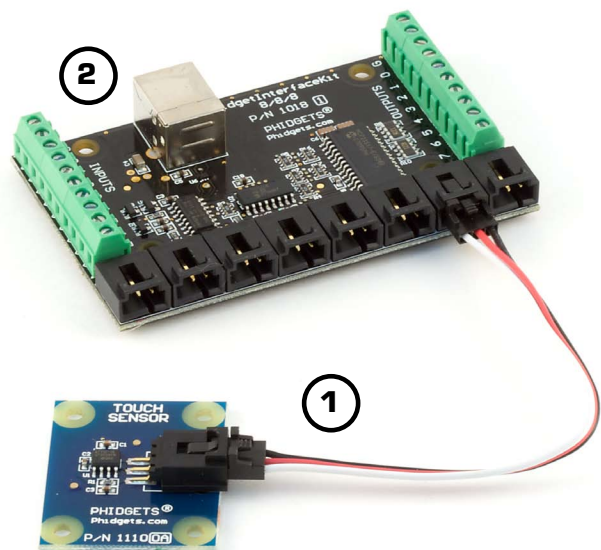

Testing Using Windows 2000/XP/Vista

Downloading the Phidgets drivers

Make sure that you have the current version of the Phidget library installed on your PC. If you don't, do the following:

Go to www.phidgets.com >> Drivers

Download and run Phidget21 Installer (32-bit, or 64-bit, depending on your PC)

You should see the  icon on the right hand corner of the Task Bar.

Running Phidgets Sample Program

Double clicking on the  icon loads the Phidget Control Panel; we will use this program to make sure that your new Phidget works properly. Since the sensor is connected to a 1018, the computer will see only the 1018. The sensor is providing data through the Analog input it is connected to.

The source code for the InterfaceKit-full sample program can be found under C# by clicking on www.phidgets.com >> Programming.

Double Click on the  icon to activate the Phidget Control Panel and make sure that the **Phidget InterfaceKit 8/8/8** is properly attached to your PC.

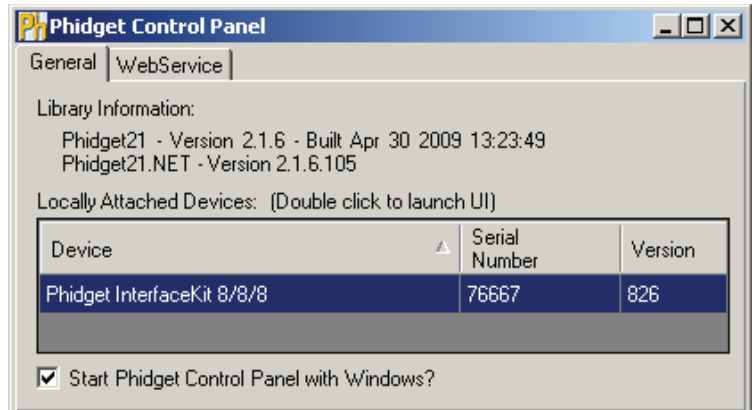

1. Double Click on **Phidget InterfaceKit 8/8/8** in the Phidget Control Panel to bring up InterfaceKit-full and check that the box labelled Attached contains the word True.
2. Make sure that the Ratiometric box is Ticked.
3. Touch the back of the Sensor Board. When you touch anywhere on the flat surface, the value in the Analog In box goes to 0. It goes back to 1000 when you stop touching it.
4. You can adjust the input sensitivity by moving the slider pointer.
5. Click on the Sensors button to bring up the Advanced Sensor Form.

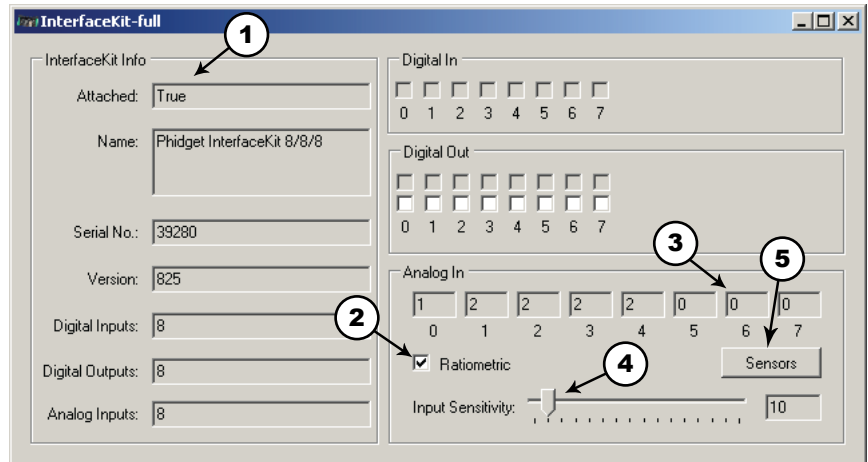

1. In the Sensor 6 box, select the 1110 - Touch Sensor from the drop down menu.
2. The sensor touch state is shown here.
3. Formula used to convert the analog input SensorValue into a touch state.

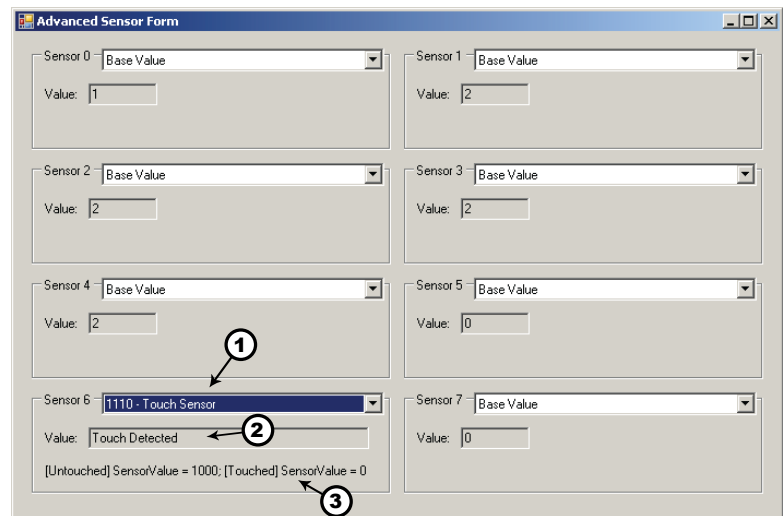

Testing Using Mac OS X

- Click on System Preferences >> Phidgets (under Other) to activate the Preference Pane
- Make sure that the Phidget InterfaceKit 8/8/8 is properly attached.
- Double Click on Phidget InterfaceKit 8/8/8 in the Phidget Preference Pane to bring up the InterfaceKit-Full example. This example will function in a similar way as the Windows version, but note that it does not include an Advanced Sensor Display.

Programming a Phidget

Phidgets' philosophy is that you do not have to be an electrical engineer in order to do projects that use devices like sensors, motors, motor controllers, and interface boards. All you need to know is how to program. We have developed a complete set of Application Programming Interfaces (API) that are supported for Windows, Mac OS X, and Linux. When it comes to languages, we support VB6, VB.NET, C#.NET, C, C++, Flash 9, Flex, Java, LabVIEW, Python, Max/MSP, and Cocoa.

Code Samples

We have written sample programs to illustrate how the APIs are used.

Due to the large number of languages and devices we support, we cannot provide examples in every language for every Phidget. Some of the examples are very minimal, and other examples will have a full-featured GUI allowing all the functionality of the device to be explored. Most developers start by modifying existing examples until they have an understanding of the architecture.

Go to www.phidgets.com >> Programming to see if there are code samples written for your device. Find the language you want to use and click on the magnifying glass besides "Code Sample". You will get a list of all the devices for which we wrote code samples in that language.

If this is your first time writing a program to control a Phidget, you should read the Getting Started Guide for the language you are planning to use.

Coding for your Sensor

Phidget analog sensors do not have their own API, but instead their output is a voltage that is converted to a digital value and accessed through the SensorValue properties and events on a PhidgetInterfaceKit. It is not possible to programmatically identify which sensor is attached to the Analog Input. Your application will need to apply any formulas from this manual to the SensorValue to translate it into usable data.

See the PhidgetInterfaceKit product manual for an overview of its API and a description of our architecture.

Technical Information

The Touch Sensor changes value from 1000 to 0 when it is touched. More specifically, this sensor is actually a capacitive change sensor. When the capacitance changes the sensor goes to zero.

It will work through 1/8 inch of glass, plastic, or paper.

If you keep touching the sensor, your touch will be calibrated out until it is no longer detected over a period of approximately 10 seconds.

Other Interfacing Alternatives

If you want maximum accuracy, you can use the RawSensorValue property from the PhidgetInterfaceKit. To adjust a formula, substitute (SensorValue) with (RawSensorValue / 4.095)

If the sensor is being interfaced to your own Analog to Digital Converter and not a Phidget device, our formulas can be modified by replacing (SensorValue) with (Vin * 200). It is important to consider the voltage reference and input voltage range of your ADC for full accuracy and range.

Analog Input Cable Connectors

Each Analog Input uses a 3-pin, 0.100 inch pitch locking connector. Pictured here is a plug with the connections labeled. The connectors are commonly available - refer to the Table below for manufacturer part numbers.

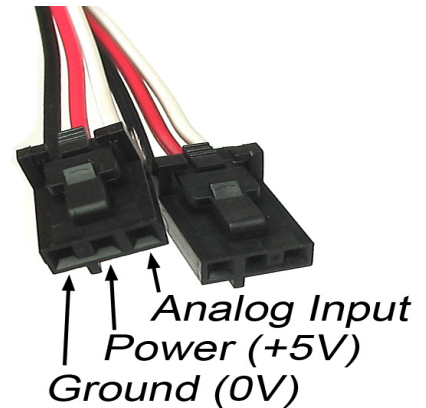

Cable Connectors		
Manufacturer	Part Number	Description
Molex	50-57-9403	3 Position Cable Connector
Molex	16-02-0102	Wire Crimp Insert for Cable Connector
Molex	70543-0002	3 Position Vertical PCB Connector
Molex	70553-0002	3 Position Right-Angle PCB Connector (Gold)
Molex	70553-0037	3 Position Right-Angle PCB Connector (Tin)
Molex	15-91-2035	3 Position Right-Angle PCB Connector - Surface Mount

Note: Most of the above components can be bought at www.digikey.com

Mechanical Drawing

1:1 scale

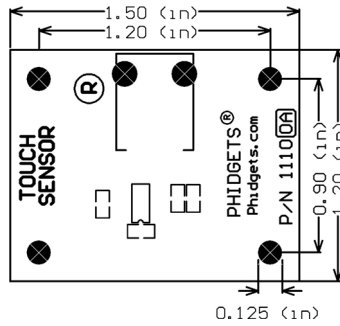

Note: When printing the mechanical drawing, "Page Scaling" in the Print panel must be set to "None" to avoid re-sizing the image.

Device Specifications

Characteristic	Value
Current Consumption	150uA
Output Impedance	10K ohms
Supply Voltage	3.0VDC to 5.25VDC

Product History

Date	Board Revision	Comment
June 2002		Product Release
August 2004		Analog input connector changed from stereo jack to 3-pin Molex
May 2008	0A	

Support

Call the support desk at 1.403.282.7335 8:00 AM to 5:00 PM Mountain Time (US & Canada) - GMT-07:00

or

E-mail us at: support@phidgets.com