

# Specification

Part No.:YK5014URC-BA

## Main descriptions:

- Device Outline: 5mm Round
- Viewing angle:15°
- Single color: Red
- Water Clear epoxy lens
- High intensity, reliability and long life
- Environmental friendly, RoHs compliant

---

Add: No. 188 Beihai Road, Jiangbei District, Ningbo, Zhejiang, China

Tel:+86-574-83092210, 83092212 Fax:+86-574-83092213

[Http://www.yongking.com](http://www.yongking.com)

E-mail: sales@yongking.com

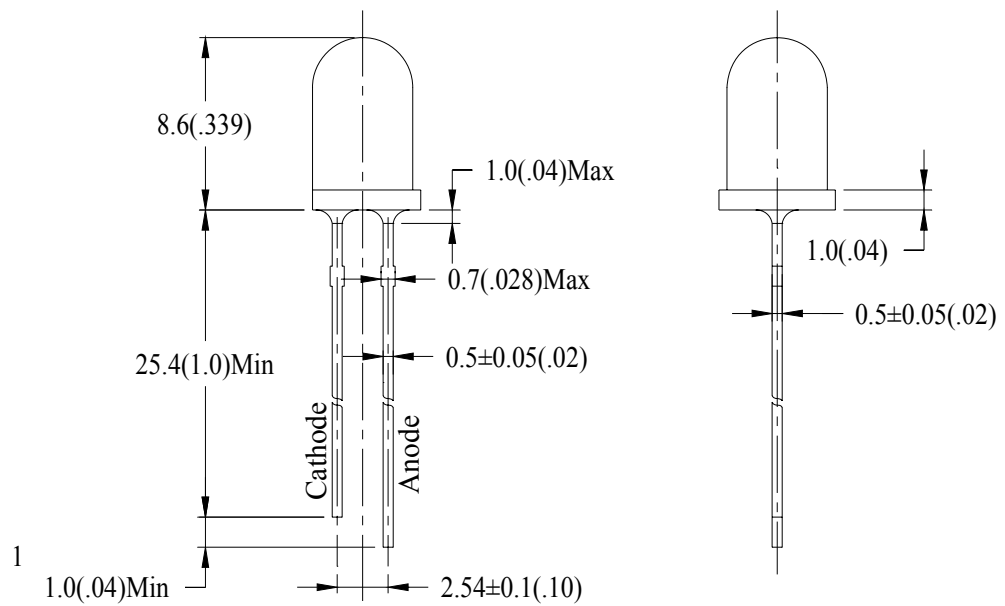
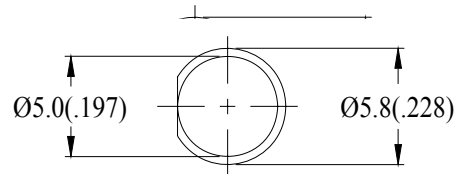

Part No	Dice material	Lens color	Emitting Color
YK5014URC-BA	AlGaInP	Water Clear	Red

**Note:**

1. All dimensions are in millilitre (inches).
2. Tolerance is  $\pm 0.25$  mm (.010") unless other noted.
3. Specifications are subject to change without notice.
4. Bare iron is exposed at tie-bar portion after cutting. The lamps have sharp and hard points that may injure human eyes or fingers etc., so please pay enough care in the handing.

● Absolute maximum ratings (Ta = 25°C)

Parameter	Symbol	Test Condition	Values		Unit
			Min	Max	
Reverse Voltage	VR	IR=10uA	--	7	V
Forward Current	IF	---	--	20	mA
Power Dissipation	Pd	---	--	50	mW
Pulse Current	Ipeak	Duty=0.1mS, 1kHz	--	100	mA
Operating Temperature	Topr	---	-30	80	°C
Storage Temperature	Tstr	---	-30	80	°C

●Electrical and optical characteristics (Ta = 25°C)

Parameter	Symbol	Test Condition	Values			Unit
			Min	Avg	Max	
Forward Voltage	VF	IF=20mA	1.9	2.1	2.4	V
Reverse Current	IR	VR=7V			5	uA
Dominate Wavelength	$\lambda D$	IF=20mA	620	625	630	nm
Luminous Intensity	IV	IF=20mA	3000	3200	4000	mcd
Viewing Angle	2 $\theta$ 1/2	IF=20mA		15		Deg

## Reliability

### 1. Test Items and Results

Test Item	Standard Test Method	Test Conditions	Note	Number of Damaged
Resistance to Soldering Heat	JEITA ED-4701 300 302	Tsld=260±5°C,10sec 1.6mm from the base of the epoxy bulb	1 time	0/100
Solderability	JEITA ED-4701 300 303	Tsld=235±5°C,5sec(using flux)	1time over 95%	0/100
Thermal Shock	JEITA ED-4701 300 307	0°C↔100°C 15sec,15sec	100 cycles	0/100
Temperature Cycle	JEITA ED-4701 100 105	-40°C~25°C~100°C~25°C 30min,5min,30min,5min	100 cycles	0/100
Moisture Resistance Cynic	JEITA ED-4701 200 203	25°C~65°C~-10°C 90%RH 24hrs/1cycle	10 cycles	0/100
High Temperature Storage	JEITA ED-4701 200 201	Ta=100°C	1000hrs	0/100
Terminal Strength (Pull test)	JEITA ED-4701 400 401	add 10N (1kgf) 10±1sec	No noticeable damage	0/100
Terminal Strength (bending test)	JEITA ED-4701 400 401	Load 5N (0.5kgf) 0°~90°~0° bend 2 times	No noticeable damage	0/100
Temperature Humidity Storage	JEITA ED-4701 100 103	Ta=60°C,RH=90%	1000hrs	0/100
Low Temperature Storage	JEITA ED-4701 200 202	Ta=-40°C	1000hrs	0/100
Steady State Operating Life	—	Ta=25°C, If=20mA	1000hrs	0/100
Steady State Operating Life of High Humidity Heat	—	Ta=60°C,RH=90%,If=20mA	500hrs	0/100
Steady State Operating Life of Low Temperature	—	Ta=-30°C, If=20mA	1000hrs	0/100

### 2. Criteria For Judging The Damage

Item	Symbol	Test Conditions	Criteria for Judgement	
			Min	Max
Forward Voltage	V <sub>F</sub>	I <sub>F</sub> =20mA	—	F.V.*)×1.1
Reverse Current	I <sub>R</sub>	V <sub>R</sub> =5V	—	F.V.*)×2.0
Luminous Intensity	I <sub>v</sub>	I <sub>F</sub> =20mA	F.V.*)×0.7	—

### ■ Spectrum Distribution

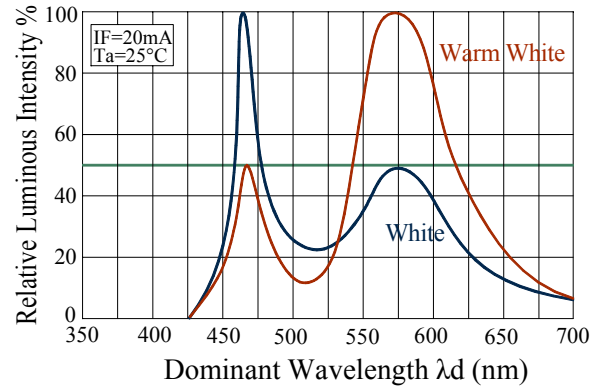
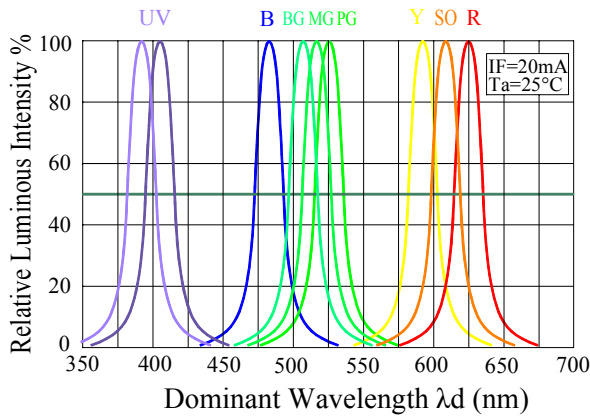

### ■ Forward Voltage Vs Forward Current

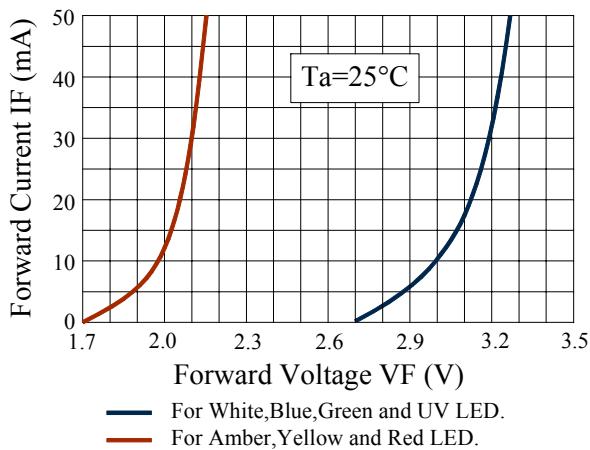

### ■ Forward Current Vs Relative Luminous Intensity

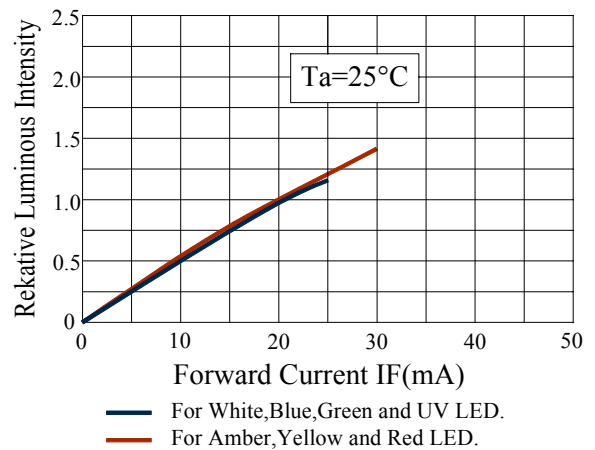

### ■ Ambient Temperature Vs Forward Current

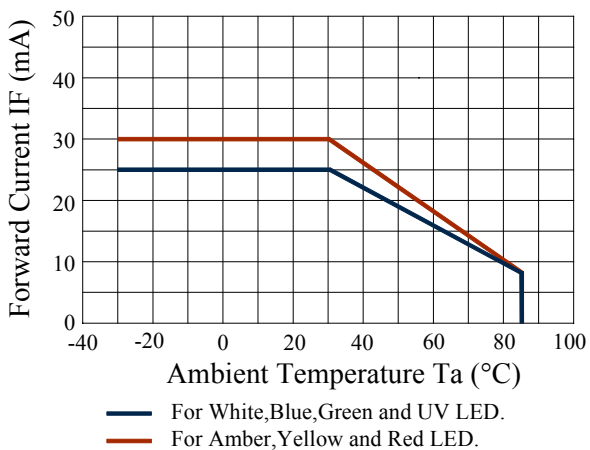

### ■ Directivity

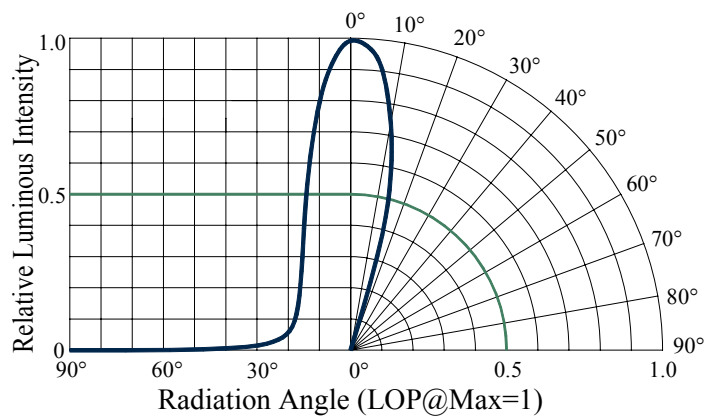

➤ **Cautions:**

**1. Lead Forming**

- 1.1) Any forming on the lead must be done before soldering, not during or after soldering.
- 1.2) Avoid applying any stress to resin for preventing the epoxy fracture and break up bonding wire.
- 1.3) While forming, please use a tie bar cut or equivalent to hold or bend the pin.
- 1.4) 2mm from the base or resin is the minimum of distance for the bending point at the lead pin.
- 1.5) Avoid bending the lead pin at the same point twice or more.

**2. Cleaning**

- 2.1) It is recommended that isopropyl alcohol be used as a solvent for cleaning the LED. When using other solvents, it should be confirmed beforehand whether the solvents would dissolve the resin or not.
- 2.2) Do not clean the LED with the ultrasonic. When it is absolutely necessary, the influence of ultrasonic cleaning on the LED depends on factors such as ultrasonic power and the assembled condition. Before cleaning, a pretest should be done to confirm whether any damages to the LED would occur.

**3. Soldering**

- 3.1) Pin hole pitch on PCB must match lead pin pitch so as not to cause any stress on lead wires.
- 3.2) No heat should be applied to lead pins when they are soldered, otherwise disconnection may occur.
- 3.3) Three minutes are necessary for LED to cool down to normal room temperature.

**4. Static Electricity**

- 4.1) Static electricity or surge voltage damages the LED. It is recommended that a wrist band or an anti-electrostatic glove be used when handling the LED.
- 4.2) All devices, equipment and machinery must be properly grounded. It is recommended that measures be taken against surge voltage to the equipment that mounts the LED.
- 4.3) When inspecting the final products in which LED were assembled, it is recommended to check whether the assembled LED are damaged by static electricity or not. It is easy to find static-damaged LED by a light-on test or a  $V_F$  test at a lower current (below 1 mA is recommended).
- 4.4) Damaged LED will show some unusual characteristics such as the leak current remarkably increases, the forward voltage becomes lower, or the LED do not light at the low current.

**5. Heat Generation**

- 5.1) Thermal design of the end product is very importance. Please consider the heat generation of the LED when making the system design. The coefficient of temperature increase per input electric power is affected by the thermal resistance of the PCB board and the placement of the LED, as well as other components. It is necessary to

THE END